



LAMILUX SKYLIGHTS  
ROOFS OF LIGHT

# LAMILUX SKYLIGHTS – MAXIMUM EFFICIENCY

---

"Modern construction is shaped by the topic of energy efficiency. Skylights in industrial and administrative buildings, aesthetic showpiece buildings and private residences are regarded as an integral part of energy-efficient building constructions. At LAMILUX, we focus on the permanent development of innovative daylight solutions for sustainable and energy-efficient construction of the future."

**Dr. Heinrich Strunz**

Executive Manager LAMILUX Heinrich Strunz GmbH



## The LAMILUX CI Philosophy

Customer value is the reason we exist – and the focus of our activities. This requires harmony, identity and a balance between customer value and company strategy.

The principles that guide our company's actions and customer relations are set out in LAMILUX's company philosophy:

**Customized Intelligence – serving customers is our first priority:**

This requires outstanding performance and leadership in all areas relevant to customers, particularly in the role of:

- A leader in quality – optimum benefit for customers
- A leader in innovation – at the cutting edge of technology
- A leader in service – fast, uncomplicated, reliable and friendly
- A leader in expertise – optimum sales and technical advisory services
- A leader in solving problems – customised, made-to-order solutions

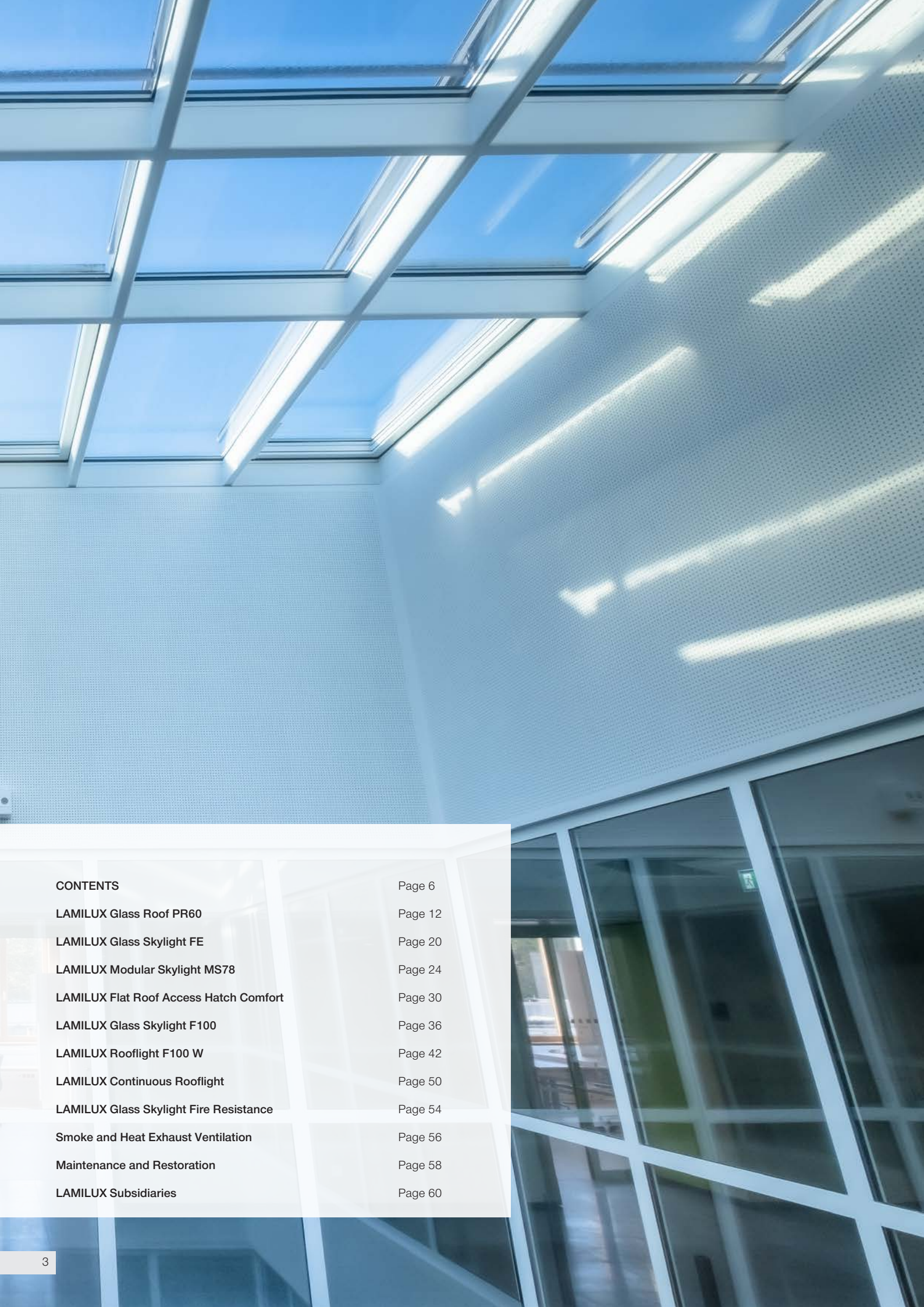

<b>CONTENTS</b>	Page 6
<b>LAMILUX Glass Roof PR60</b>	Page 12
<b>LAMILUX Glass Skylight FE</b>	Page 20
<b>LAMILUX Modular Skylight MS78</b>	Page 24
<b>LAMILUX Flat Roof Access Hatch Comfort</b>	Page 30
<b>LAMILUX Glass Skylight F100</b>	Page 36
<b>LAMILUX Rooflight F100 W</b>	Page 42
<b>LAMILUX Continuous Rooflight</b>	Page 50
<b>LAMILUX Glass Skylight Fire Resistance</b>	Page 54
<b>Smoke and Heat Exhaust Ventilation</b>	Page 56
<b>Maintenance and Restoration</b>	Page 58
<b>LAMILUX Subsidiaries</b>	Page 60

LAMILUX GLASS ROOF PR60  
PAGE 6

LAMILUX GLASS SKYLIGHT FE  
PAGE 12

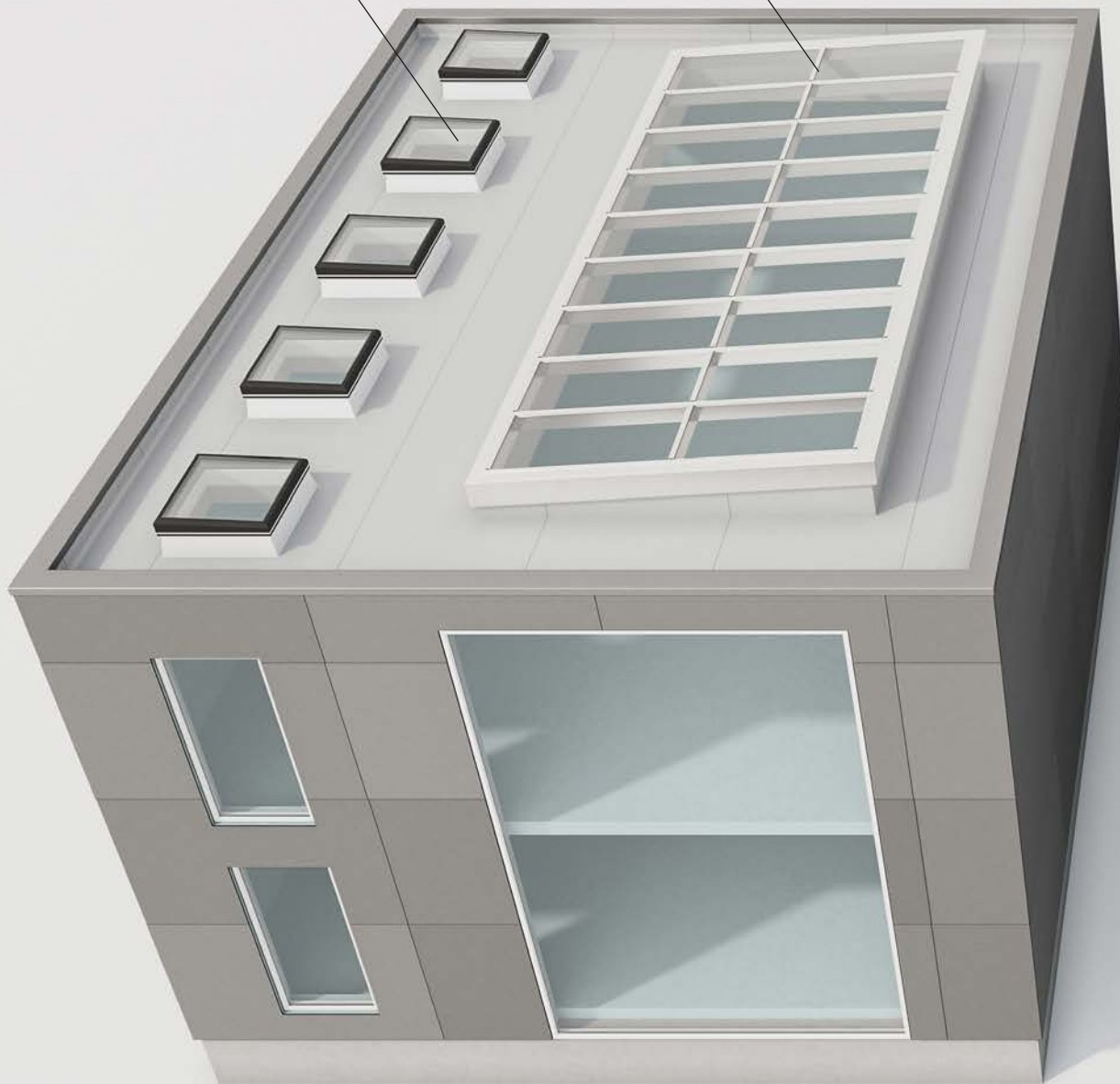

LAMILUX ROOFLIGHT F100 W  
PAGE 26

LAMILUX CONTINUOUS ROOFLIGHT B/S  
PAGE 44

LAMILUX TRANSLUCENT FAÇADE AND ROOF  
PAGE 40

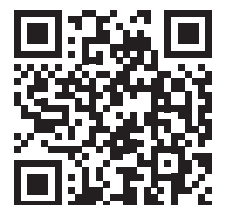

# BIM AND PRODUCT CONFIGURATOR – FOR LAMILUX DAYLIGHTSYSTEMS

**Create only one space required an individual product variant, guided by a dynamic dialogue with 3D preview in real time. Then share, request with one click or download BIM objects, 2D and 3D CAD models, images, dimensional drawings or data sheets in the desired file format.**

Insert space BIM or without – the PDF data sheet with all technical properties including active 3D model, dimensional drawing and link back to configuration is the ideal all-in-one document of your desired product variant. Generate it yourself now 24/7. Avoid transmission errors and misunderstandings on long chains of tenders, requests and quotations. Download BIM objects and equip the model with data and information from all project participants throughout the entire planning process.

✔ Use reliable BIM objects of our skylights right from the start instead of planning placeholders whose geometry and properties or even availability are unclear. You can make changes directly in the building model as you proceed, reliable due to our parametric models or even more variable via a plug-in in the configurator.

✔ The final variant of the skylight system can be requested and ordered with just a few clicks for the configurator-based model, using ID with variant accuracy. This avoids transmission errors and misunderstandings on long chains of tenders, requests and offers.

✔ Generate data sheets for the product variant directly in the configurator or store supplied documents via a link to the components in the building model.

## 3D/2D

## share-function

## request

## data sheets

## BIM

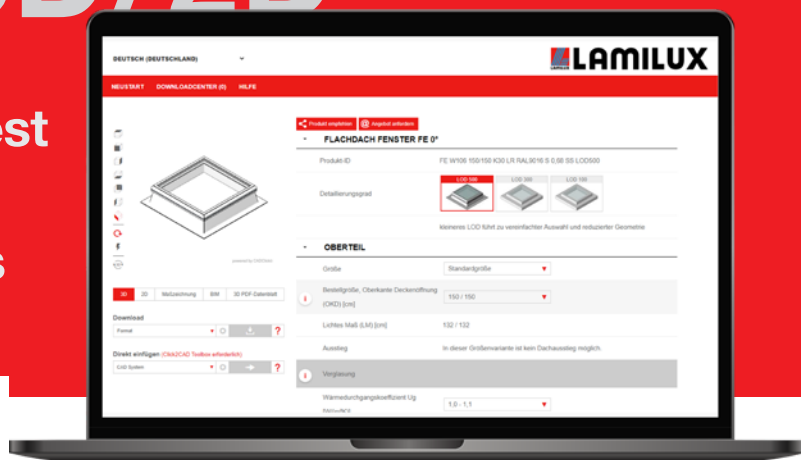

Check out this qr code and test our product configurator.

For more information check our website.  
[www.lamilux.com/bim](http://www.lamilux.com/bim)



# AUGMENTED REALITY – EXPERIENCE OUR PRODUCTS ON YOUR SMARTPHONE

Immerse yourself in the world of virtual reality and explore the product in a real environment. Visit the LAMILUX World and scan the QR codes with your smartphone or tablet.

Choose between flat roof windows, skylight domes or flat roof egresses. Using Augmented reality you can make the product of your choice appear in the place of your choice, for example the future location and view how the product might look in place. View the product from all sides or change the size. With Augmented a connection between the real and the virtual reality is achieved.



Glass Skylight  
F100



Glass Skylight  
F100 circular



Glass Skylight  
FE



Glass Skylight  
FE 3°



Rooflight  
F100 W



Rooflight  
F100 circular



Flat Roof Access Hatch  
Comfort Quadrat



Flat Roof Access Hatch  
Comfort Swing



LAMILUX

GLASS ROOF PR60





# LAMILUX

## GLASS ROOF PR60

---

**Design glass roofs that are tailored to the individuality of your building project: The LAMILUX Glass Roof PR60 is based on a highly flexible mullion-transom system and enables almost all conceivable shapes at angles between zero and 90 degrees: from saddleback and hipped roofs, pyramids and arched roofs to fully customised geometries.**

The system has considerable dimensional stability, particularly at the supporting joints, thanks to the specially interlocking slide-in connectors. This even facilitates complicated profile joints without any difficulty.

In addition, the narrow face width of the profiles (60 millimetres) ensures a high level of daylight intake – hence the 60 in the name of our mullion-transom construction. The LAMILUX Glass Roof PR60 is available in many glazing types, such as heat insulation glass, sun protection and sound insulation glass as well as light-guiding and light-dispersing glazing types. The large number of optional shade systems ensure controlled daylight intake.

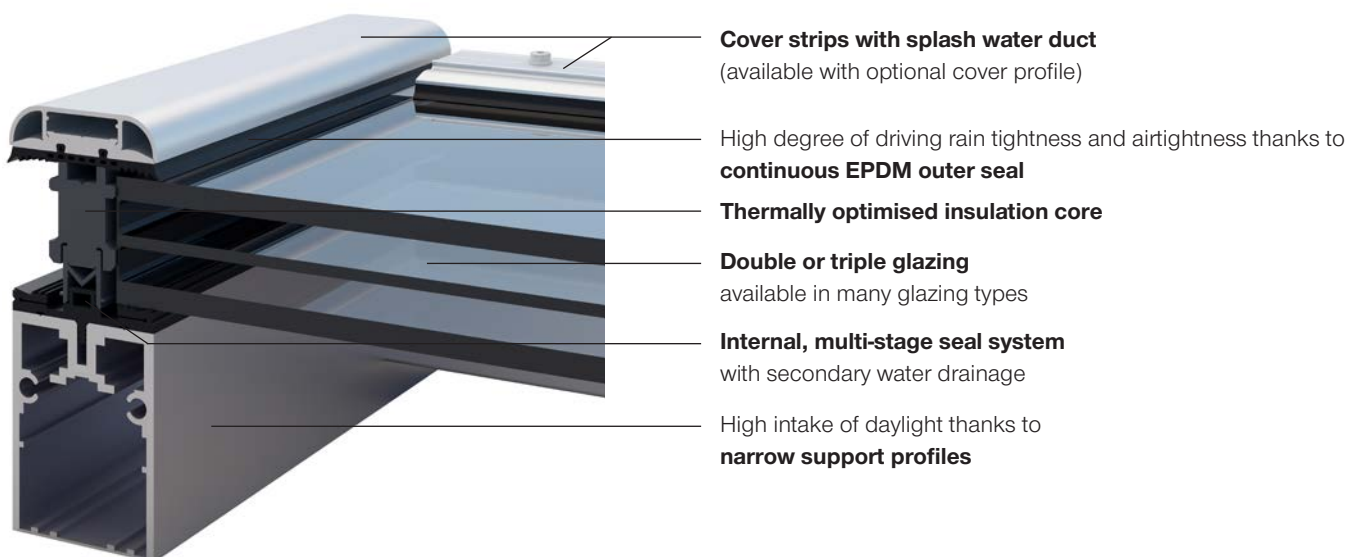

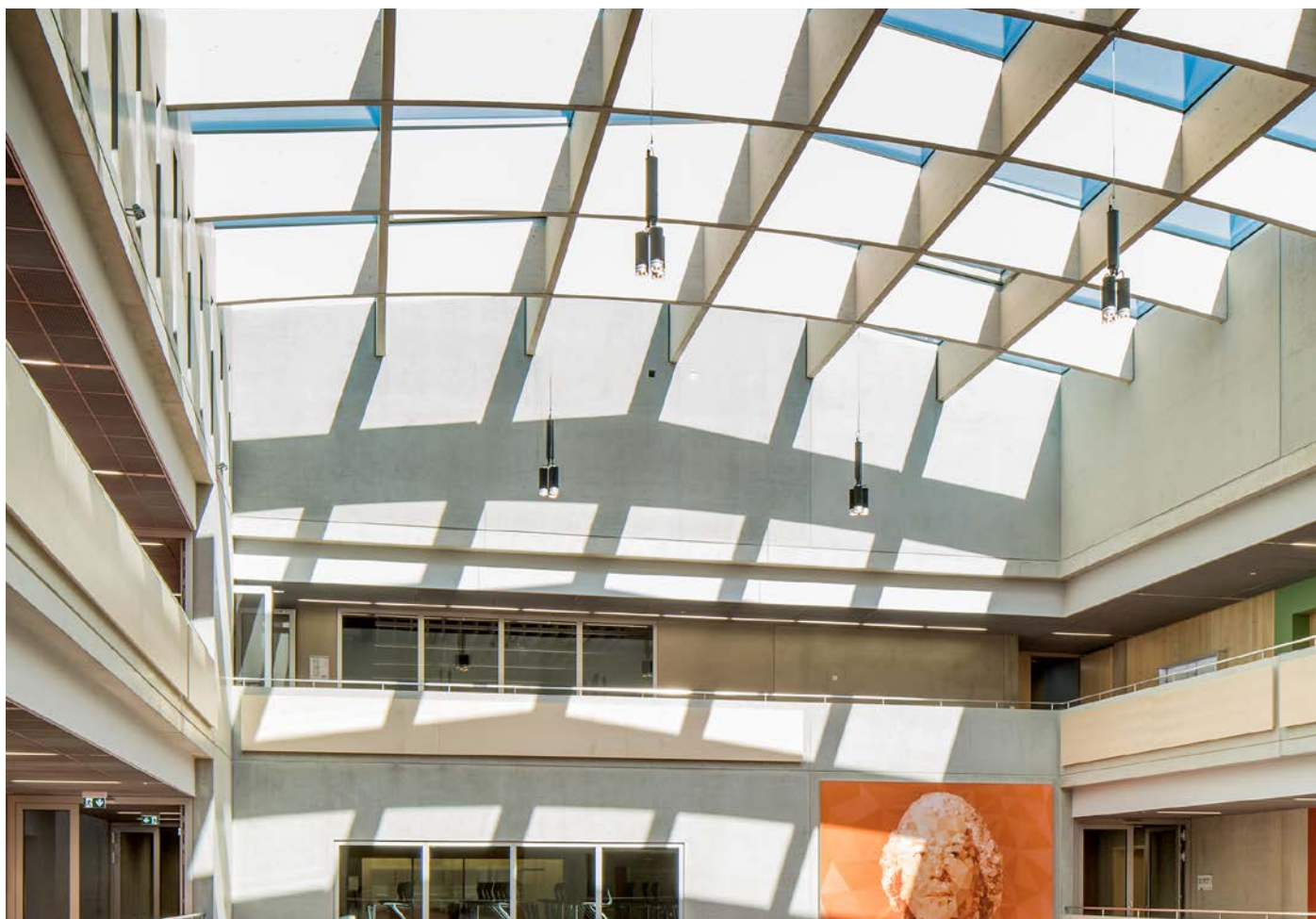

Product variant LAMILUX Glass Roof PR60 Passivhaus

## ENERGY EFFICIENCY

Savings on heating costs and minimised risk of condensation thanks to optimal isothermal characteristics

All-round optimum thermal insulation in a thermally separated overall construction

Preservation of a lot of thermal energy in the building thanks to the tight overall system

Passivhaus-certified variant (phA) with optimised thermal insulation and excellent airtightness values

## COMFORT & DESIGN

Unique full service thanks to planning, construction and installation of the glass structure from a single source

Made-to-order complete solutions for daylight, SHEV, ventilation and control technology

Narrow supporting profiles ensure an unobstructed view to the outside and a high intake of daylight

LAMILUX Ventilation Flap PR60 in an architecturally appealing design with a roof upstand of only 40 mm

## FUNCTIONALITY IN EXTREME WEATHER CONDITIONS

Tested watertightness in heavy rain and during storms (imperious to driving rain, in accordance with DIN EN 13830, Class RE1950)

High resistance to wind loads (2000 Pa as per DIN EN 13830)

Outstanding airtightness (AE 3000 positive test pressure as per DIN EN 13830)

Optimised soundproofing and minimised rain noise thanks to special glazing ( $R_w = 46$  dB as per EN 10140-2)

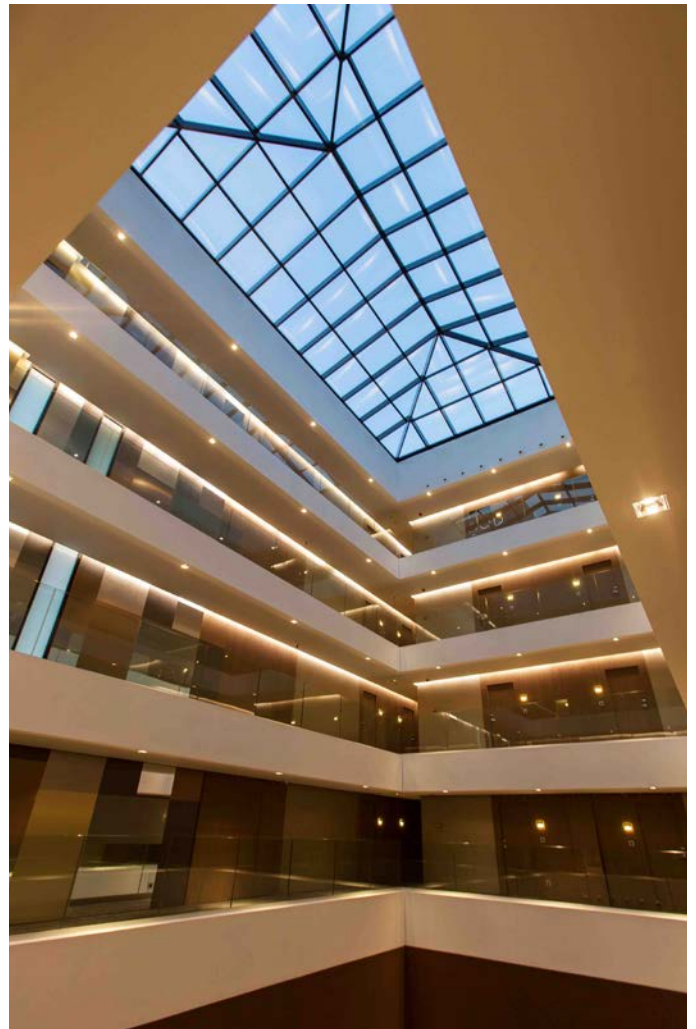

## BMW GROUP FIZ, MUNICH

### Project:

Complete renovation of a four-storey building, used for product development, to reconfigure the layout giving best use of space. Covering of the area located between the main and outer building with a special glass construction.

### Systems:

- Glass roof construction composed of 60 axes each with 15 panes
- A total of 900 panes, 225 of which have a unique shape
- Removal of the old and installation of the new glass roof while normal operations continued
- Elevated installation of the glass panes to compensate for any deflection

## HOTEL DON CARLOS, MARBELLA | SPAIN

### Project:

Installation of a hipped glass roof over the atrium of the Wellness Resort. Reduction of energy demand for lighting and air conditioning.

### Systems:

- A LAMILUX PR60 Glass Roof with a width of 7.5 m and a length of 13.2 m with a roof pitch of 15°



## SINGLE FAMILY HOUSE, NORTH GERMANY

### Project:

New construction of a spacious single family house with a focus on maximum, show-stopping daylight intake.

### Systems:

- One LAMILUX Glass Roof PR60 in a pyramid shape with a surface inclination of 25° and structural roof opening size of 4 x 4 m
- Two integrated LAMILUX Ventilation Flaps PR60 for daily ventilation



## FACULTY OF ARTS, WARWICK | ENGLAND

### Project:

A new construction, of the research centre of the Faculty of Arts department at the University of Warwick, was constructed with four pavilions grouped around a large central staircase and flooded with light by two PR60 Glass Roofs.

### Systems:

- Two Glass Roof PR60 rooflights with a 5° inclination with the largest measuring around 8m x 8m.



LAMILUX

GLASS SKYLIGHT FE



# LAMILUX GLASS SKYLIGHT FE

---

**Sophisticated design in a number of variants: The redevelopment of the LAMILUX Glass Skylight FE represents a milestone in product development at LAMILUX. Architects, builders and building users benefit from an innovative frame profile and sophisticated design features with a wealth of additional benefits. For this, the skylight received the German Design Award 2019, the Red Dot Award 2019 as well as two Plus X Awards.**

The design of the new LAMILUX Glass Skylight FE can also be adapted to any construction project's overall architectural concept. Design freedom is offered with a wide variety of glazing and sizes up to 2.5 x 2.5 metres. In addition the drive concealed within the profile frame and the freely selectable exterior and interior colours of the skylight offer choice and flexibility. Just as impressive is its all-round optimum thermal insulation in a compact overall system free of thermal bridges and certification in Passivhaus class pHc.

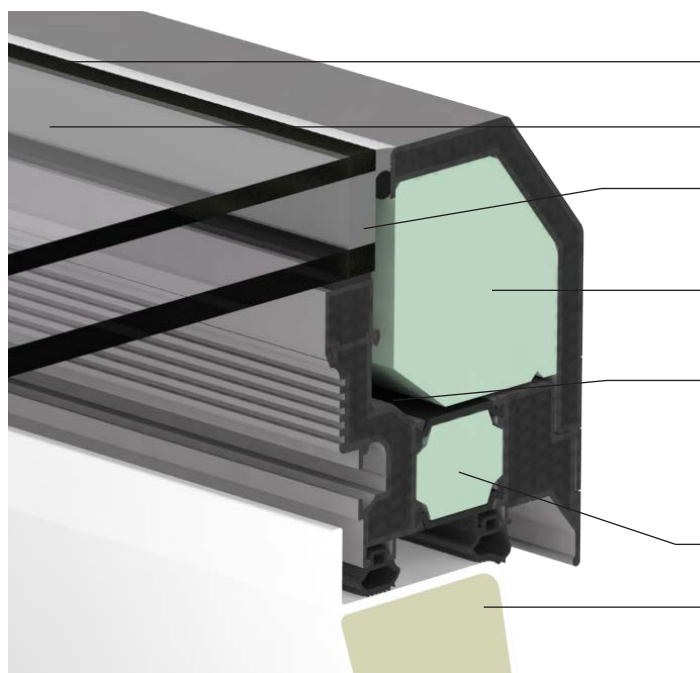

**Structural Glazing design**

**Flat drainage surface**

**"Warm edge"** (spacers between the panes, made of materials with low thermal conductivity) **as a standard feature**

**Integration of all drives** and components in the profile frame

**TAD – Thermo Active Design:** A patented component below the glazing support for surface enlargement absorbs more heat energy from the room air contributing to the optimised isothermal curve

**Thermally optimised insulation core**

**Insulated GRP upstand:** Manufactured without joints (optional) and with a continuous insulation core made of 60 mm thick PU foam



**ENERGY EFFICIENCY**

Savings on heating costs and minimised risk of condensation thanks to flawless isothermal characteristics

All-round optimum thermal insulation in a compact overall system free of thermal bridges and certification in Passivhaus class pHc

Preservation of thermal energy in the building thanks to the tight overall system

Seamless and vapour-tight upstand made of glass-fibre reinforced composite with integrated insulation

**COMFORT & DESIGN**

Uniform appearance throughout thanks to new joining technology: no visible screw joints or weld seams as well as four-sided flat water drainage

Easy installation thanks to completely pre-assembled delivery of the skylight

The integration of all drives, power adapters, cables and other components into the frame of the skylight creates a smooth interior design

Variety of design and colours thanks to freely selectable exterior and interior colours of the flat roof skylight

**FUNCTIONALITY IN EXTREME WEATHER CONDITIONS**

Tested watertightness in heavy rain and during storms (highly impervious to driving rain, in accordance with DIN EN 12208, Class E 1950)

High stability against wind load (highest wind load class C5 according to DIN EN 12210)

Excellent air permeability (performance class 4 – DIN EN 12207)

Optimised sound insulation and minimised rain noise due to special glazing ( $R_w = 38$  dB)

**SAFETY**

Approved fall-through protection as per DIN 18008-6

Preventive fire protection according to DIN 18234: Prevents fire spreading on the roof without additional measures

Use as a smoke outlet in stairwells

High hail resistance due to TSG exterior pane as standard



Product variant LAMILUX Glass Skylight FE 3°



Product variant LAMILUX Glass Skylight FE Pyramid or FE Hipped



Product variant LAMILUX Glass Skylight FE Circular



Product variant LAMILUX Glass Skylight FE Passivhaus

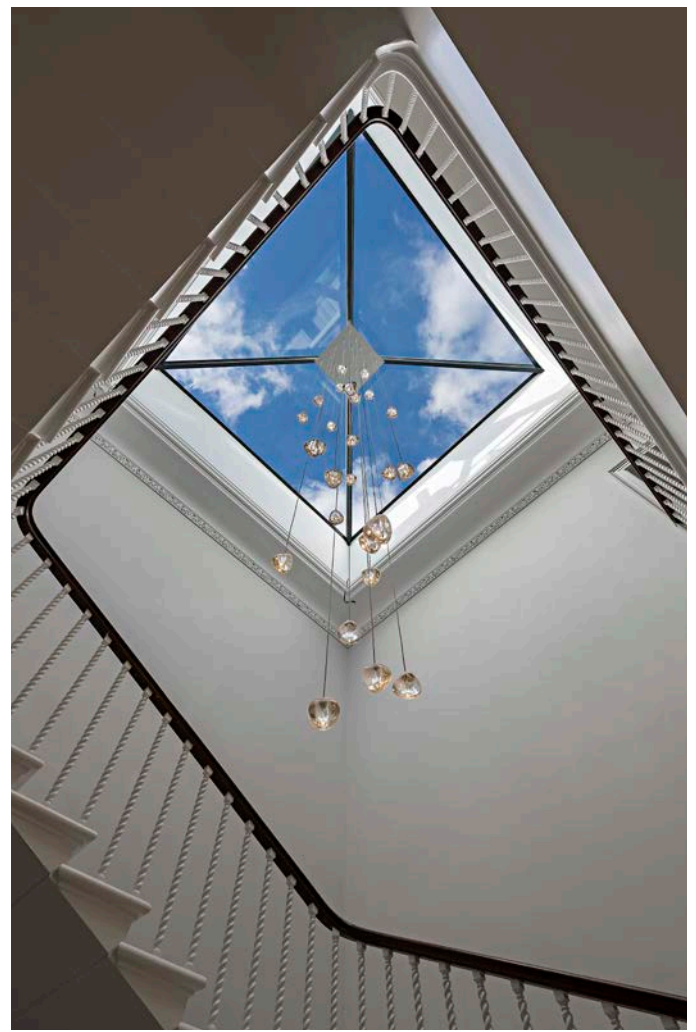

## HUMBOLDT UNIVERSITY, BERLIN

### Project:

Large-scale, natural illumination of the central library and reading area of the new building with at the same time high demands on the thermal insulation of the skylights.

### Systems:

- 92 elements of the type LAMILUX Glass Skylight FE 3° in the dimensions 250 x 250 cm
- Partly designed as natural ventilation and with SHEV function
- Top structures made of glass-fibre reinforced plastic with inside cladding of coated sheet steel
- Sun protection glazing with 50% light transmittance and 17% energy transmittance

## SONDES PLACE, DORKING | ENGLAND

### Project:

The mansion at Sondes Place in Surrey had sadly fallen into disrepair but has now been restored to its former glory. A Glass Skylight Pyramid was used on this renovation project to create an abundance of natural light throughout the exclusive manor.

### Systems:

- Pyramid/hipped rooflight with 30° inclination of glazed surface with the dimension 200 cm x 200 cm.



## NORRKÖPING SCHOOL, SWEDEN

### Project:

Conversion of a former industrial building into a school building. Supply of the building with natural daylight even on cloudy winter days.

### Systems:

- LAMILUX Glass Skylight FE Pyramid in the dimensions 180 x 180 cm with a  $U_g$  value of 1.1 W/(m<sup>2</sup>K) and a sound insulation value of 35 dB
- Upstands made of glass-fibre reinforced composite, 50 cm in height
- Condensate detector



## MILTON KEYNES UNIVERSITY HOSPITAL, ENGLAND

### Project:

New construction of an administration building with a focus on aesthetic, natural lighting.

### Systems:

- Six LAMILUX Glass Skylights FE Circular opening for ventilation
- 17 LAMILUX Smoke Lifts Glass Skylight F100
- Six motors in special design for flat roof windows
- Wind and rain sensor set
- SHEV central units and CO<sub>2</sub> alarm stations



LAMILUX

MODULAR GLASS SKYLIGHT MS78



# LAMILUX

## MODULAR GLASS SKYLIGHT MS78

---

**LAMILUX Modular Glass Skylight MS78 combines the advantages of two proven LAMILUX-systems – LAMILUX Glass Skylight FE and the LAMILUX Glass Roof PR60 and inspires with glass roof innovations. With large areas of light thanks to multi-pane glazing and opening vent, it provides increased daylight incidence in buildings with a width of 3 metres and variable length.**

The variable and opening vent integration of the new LAMILUX glass roof ensures high ventilation comfort and offers a uniform appearance of opening vents and fixed elements with concealed integrated drives. Architects and roofers benefit above all from short delivery times thanks to lean and automated processes as well as simple and safe roof integration thanks to the system's own connection technology.

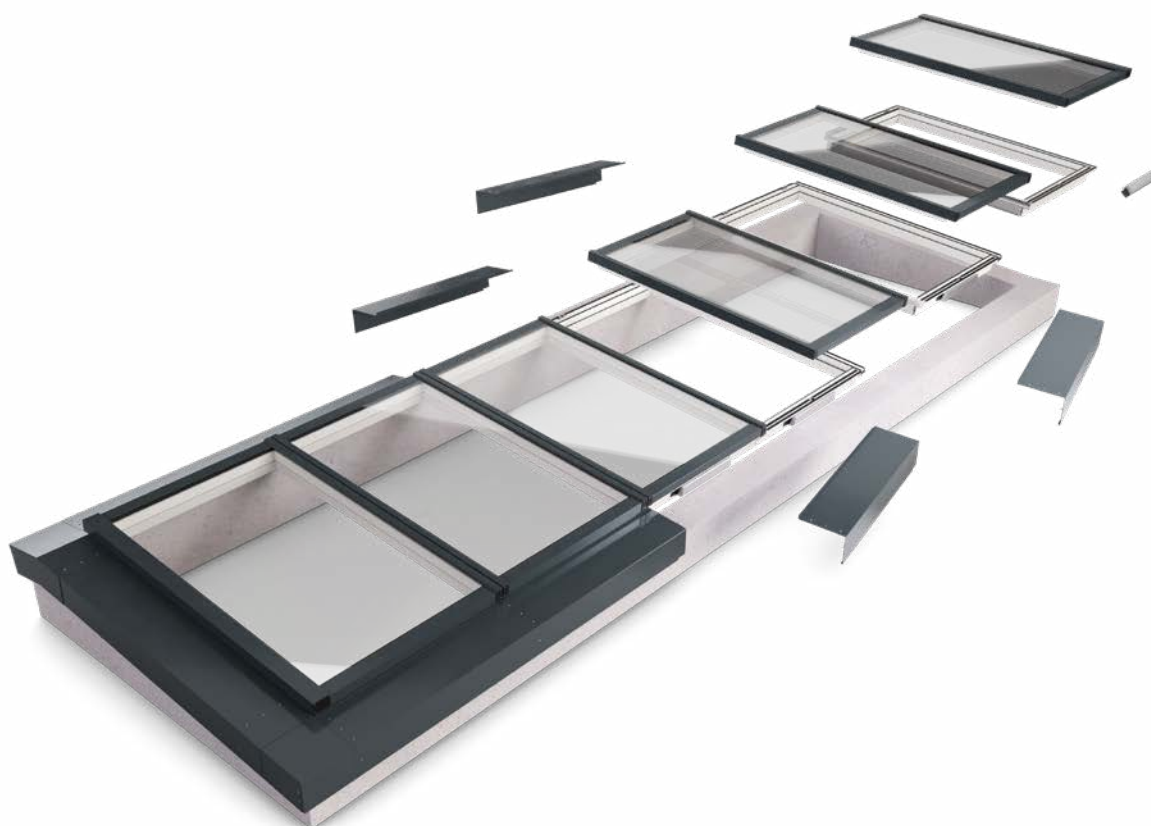





 **ENERGY EFFICIENCY AND SUSTAINABILITY**

Sustainable product terial cycle through single-origin recycling

All-round optimal thermal protection in a compact, thermal bridge-free overall system

Energy cost savings and minimized risk of condensation thanks to kink-free isothermal progression

 **PRODUCT VARIETY AND HIGH-QUALITY STANDARDS**

Uniform appearance of Opening vents and fixed elements thanks to opening vent integration (NFI)

Maximum ventilation area due to unrestricted Opening vent arrangement

High proportion of glass due to module sizes up to 1.30 m x 3.00 m

Full light surface due to Opening vent without clamping frame

 **FUNCTIONALITY AND SAFETY**

Drainage profile offers maximum safety from the first sealing level onwards

Precise installation thanks to V-groove and self-aligning module connection (SAM)

Optimised construction process thanks to complete installation from the roof side in one stage

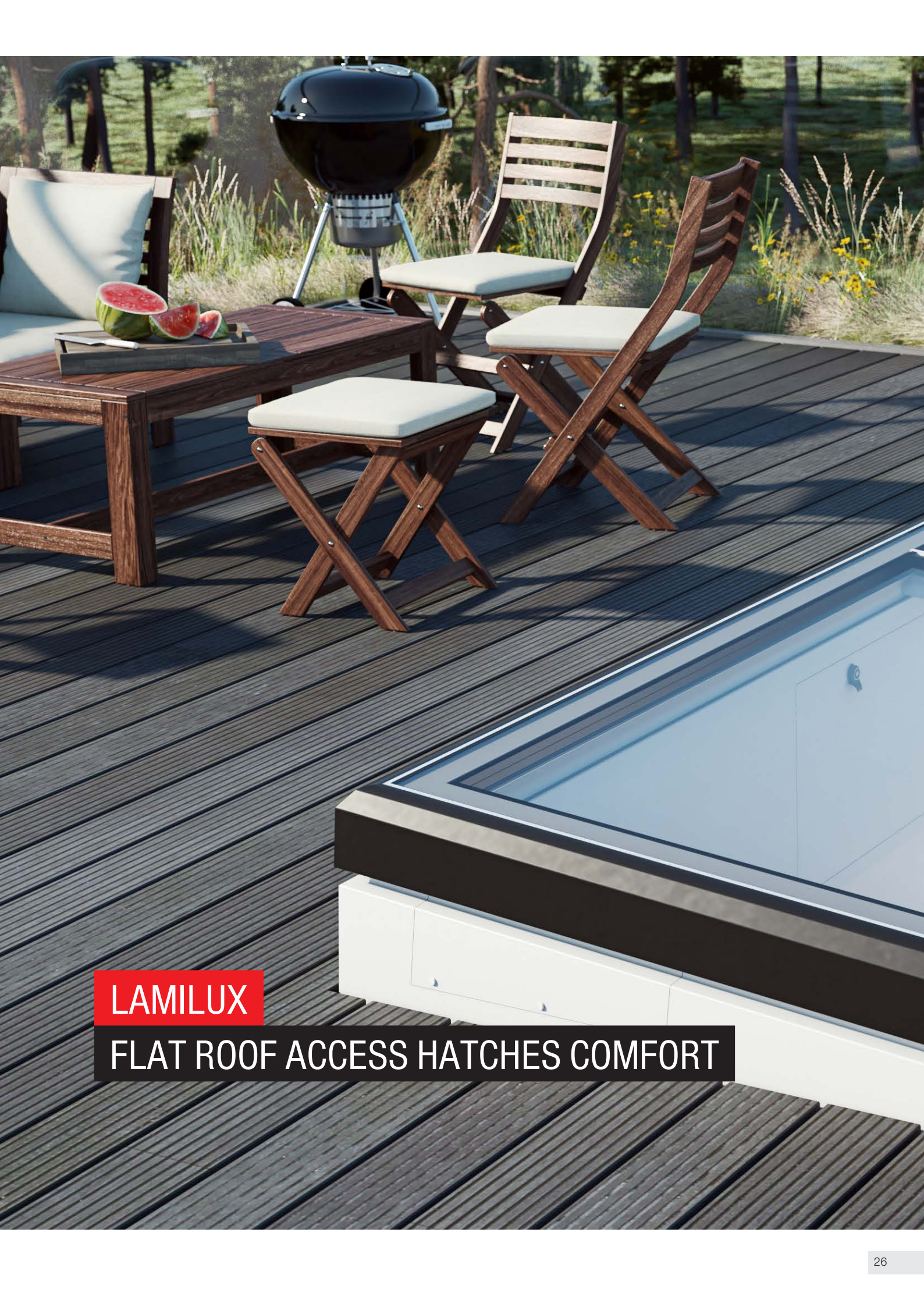

**LAMILUX**

**FLAT ROOF ACCESS HATCHES COMFORT**



reddot winner 2021

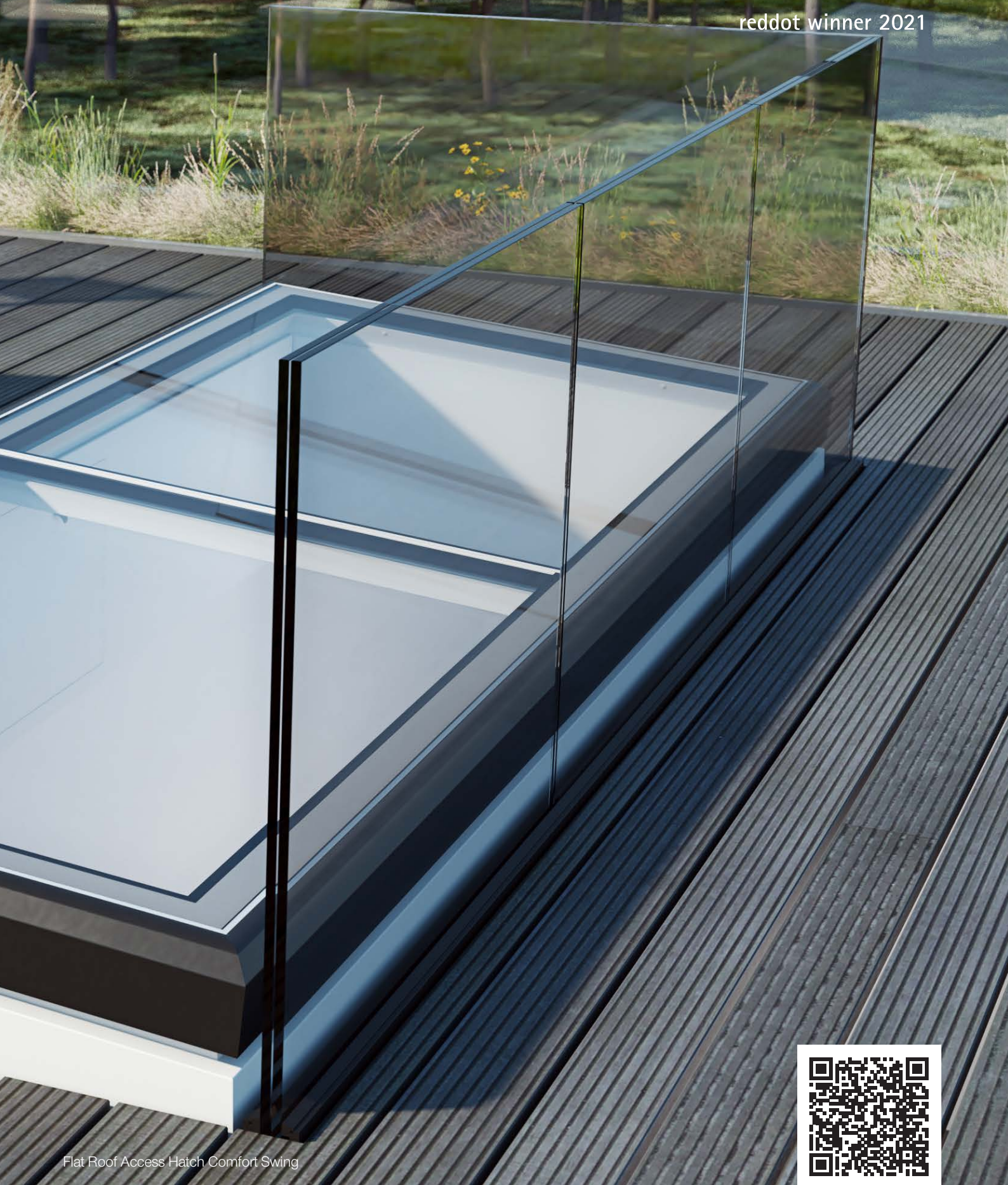

Flat Roof Access Hatch Comfort Swing



# LAMILUX FLAT ROOF ACCESS HATCH COMFORT

---

**In the past, flat roof access hatches were only used as roof access for maintenance and inspection purposes. In the meantime, other aspects of use have been added and the demands on skylights have become much more complex. In addition to optimised thermal insulation values and proven durability, the focus is mainly on architectural requirements and comfort.**

This provides a previously unattained level of daylight incidence for exclusive attic flats and creates an even more comfortable access to the roof. The indoor climate also benefits from the high energy efficiency of the systems and the unrestricted use as ventilation unit.

## Highest quality standards

To us, quality does not only mean high energy efficiency of our products, but also durability through the use of the highest quality materials, certified functional safety for daily use and perfectly shaped design.

## Pre-assembled to the construction site

We deliver all our elements completely pre-assembled to the construction site. Only the control unit for the Flat Roof Access Hatch Comfort Solo and Duo has to be installed on site. This reduces the amount of crane work, fastening and sealing required.

## Proven functionality

As a planner and installer, you benefit from the simple and fast usability of our flat roof access hatches, which brings planning security in terms of weather, saves time and costs. Once the roof is closed, dry construction can begin.



Flat Roof Access Hatch Comfort Square



Flat Roof Access Hatch Comfort Duo



Flat Roof Access Hatch Comfort Solo

 **ENERGY EFFICIENCY**

Heating cost savings and minimized risk of condensation thanks to kink-free isotherms

All-round optimum thermal insulation in a compact, thermal bridge-free overall system

Preservation of a lot of thermal energy in the building due to the frame construction

Available with high-quality functional glass (upon request)

 **COMFORT & DESIGN**

Easy to install thanks to completely pre-assembled delivery of the flat roof access hatch.

Self-cleaning - thanks to level water drainage\* and inclined upstand

Non-visible drives offer a particularly high-quality interior view

Variable ventilation with push-button function

 **SAFETY**

Roof access hatch fall-through-proof according to DIN EN 18008-6 in closed position.

Preventive fire protection according to DIN 18234: prevention of fire spreading on the roof without additional measures

Entry and exit area monitored by light barrier or motion detector

Meets the requirements of the Machinery Directive

 **PRODUCT CONFIGURATOR**

Create individual product variants, guided by a dynamic dialogue with 3D preview in real time.

Share, request or download BIM objects, 2D and 3D CAD models, images, dimensional drawings and data sheets in the desired file format with a single click

Support for your individual glass roof or continuous rooflight project



Check out this qr code and test our product configurator.

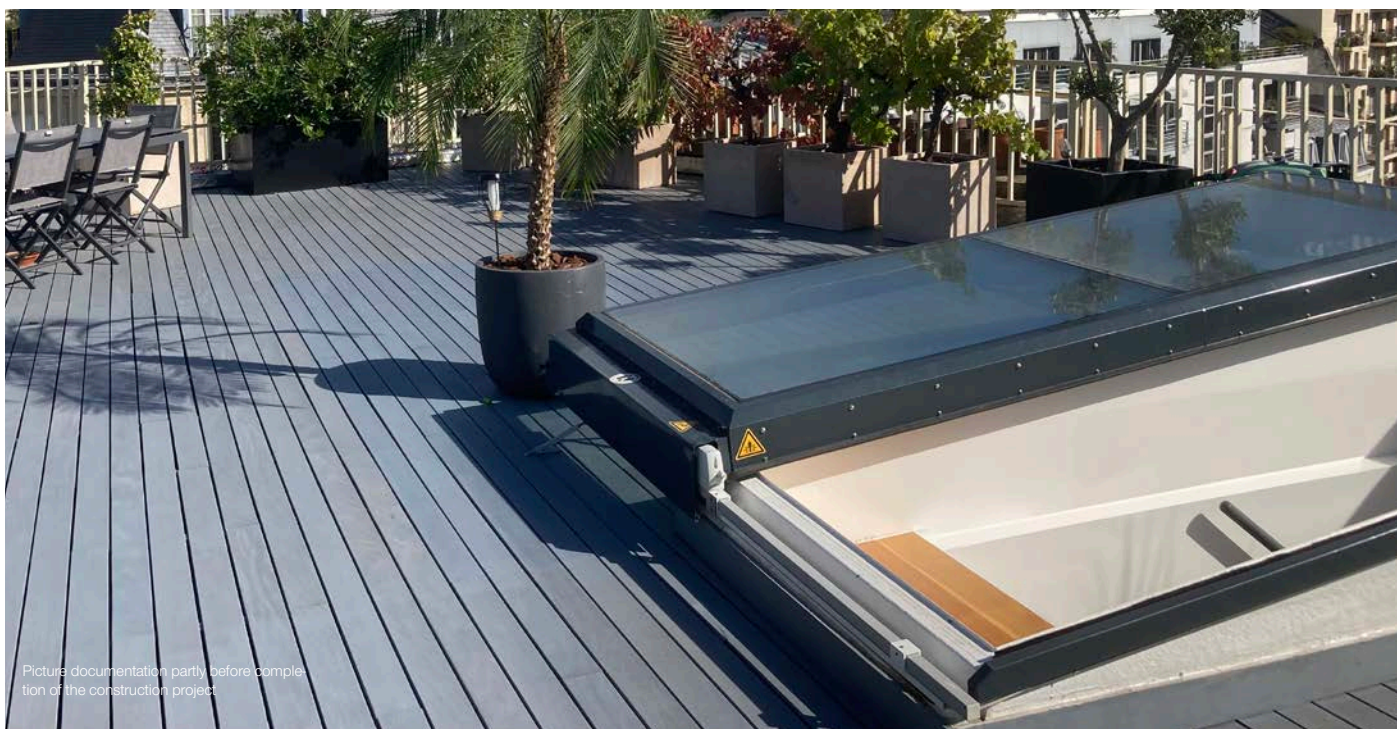

Picture documentation partly before completion of the construction project

## ACCESS HATCH COMFORT SOLO

### Residential building, Paris – France

The Flat Roof Access Hatch Comfort Solo made it possible to create a sophisticated ambience with a view over the rooftops of Paris combined with a pleasant incidence of light for the attic flats.

The overall system, free from thermal bridges, optimised isothermal processes and the option of special glazing also meet modern demands on sustainability, energy efficiency and climate protection.



## FLAT ROOF ACCESS HATCH COMFORT SOLO

### Residential building – Berlin

Due to local regulations, access via a stairwell was not possible. This could be realized though with the Flat Roof Access Hatch Comfort Solo.

A variable opening of the sash allows a roof access hatch that can also be used as a ventilation option. The control is effected via an external 24V rack and pinion drive on telescopic rails made of stainless steel with brush seal.



## FLAT ROOF ACCESS HATCH COMFORT DUO

### Residential building – Berlin

Despite limited living space, a comfortable access to the roof terrace could be created. This extends the living space and increases the property value.

A LAMILUX Flat Roof Access Hatch Comfort Duo was installed as a two-piece, horizontally opening flat roof. The sashes glide quietly on telescopic rails made of stainless steel.



## FLAT ROOF ACCESS HATCH COMFORT SWING

### Residential building – Denmark

With the Flat Roof Access Hatch Comfort Swing, a space-saving access to the roof terrace and thus an exclusive ambience could be created.

The Comfort Swing can be opened variably over the entire folding sash like a door. It has a compact, highly energy-efficient overall construction, which rests on an upstand made of glass-fibre reinforced plastic with an integrated core insulation block.



**LAMILUX**

**GLASS SKYLIGHT F100**





# LAMILUX

## GLASS SKYLIGHT F100

---

The LAMILUX Glass Skylight F100 is an energy-efficient skylight for rooms with high optical demands. Particularly in residential, administrative and office buildings, it floods rooms with daylight and fresh air. Various shading options can be used to control the amount of light and heat entering the room – conveniently controlled up to a comfortable climate.

Not only the building user, but also the builder benefits from practical advantages: The skylight is very quick and easy to install. It is completely pre-assembled on the upstand when it is delivered to the construction site and it can be fixed onto the flat roof immediately – both the ventilated and the fixed variant.

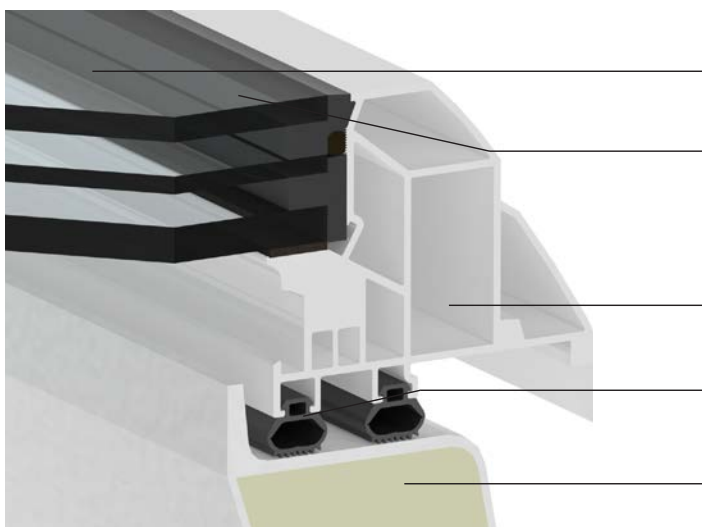

First flat roof window with national technical approval featuring a **Structural Glazing design**

**Flat drainage surface:** The unique frame profile provides a smooth transition between the glazing and the border frame, creating an unobstructed drain for rainwater

**Thermally optimised PVC border frame**

Outstanding, certified air-tightness due to the **balloon double sealing system**

**Insulated GRP upstand:** Manufactured without joints (optional) and with a continuous insulation core made of 60 mm thick PU foam; Optional ventilation drives concealed in the upstand



Product variant LAMILUX Glass Skylight F100 Circular

### ENERGY EFFICIENCY

Savings on heating costs and minimised risk of condensation thanks to flawless isothermal characteristics

All-round optimum thermal insulation in a compact, thermal-bridge-free overall system

Preservation of thermal energy in the building thanks to the tight overall system

Seamless and vapour-tight upstand made of glass-fibre reinforced composite with integrated insulation

### COMFORT & DESIGN

Optional concealed integration of all drives, cables and other components into the frame

Avoidance of internal plastering work thanks to smooth, silk-white interior finish of the upstand

Permanently clear view, infinitely variable water drainage and generous daylight incidence due to scratch-resistant glazing and uniquely designed frame profile

Optional simplification of connection work through optimum structural attachments for a wide variety of sealing techniques

### FUNCTIONALITY IN EXTREME WEATHER CONDITIONS

Tested watertightness in heavy rain and during storms (impervious to driving rain, in accordance with DIN EN 12208, Class E 1950)

Optimised sound insulation and minimised rain noise due to special glazing ( $R_w = 38$  dB)

High stability against wind and snow loads (wind load – class C4 according to DIN EN 12210)

Optional internal or external shading as well as UV-resistant edge seal against strong solar radiation

### SAFETY

Approved fall-through protection according to DIN 18008-6

Preventive fire protection according to DIN 18234: Prevents fire spreading on the roof without additional measures

Use as a smoke outlet in stairwells

Available as fully certified smoke and heat exhaust ventilation device according to DIN 12101-2



## FRONIUS, NEUHOF

### Project:

New construction of a production and administration building for the manufacturer of electrical appliances.

### Systems:

- Eight LAMILUX Glass Skylights F100
- 30 LAMILUX Rooflights F100
- One LAMILUX Continuous Rooflight B
- Five LAMILUX Smoke Lifts Continuous Rooflight B with Safety Stripes
- Two LAMILUX Glass Roofs PR60
- Eight LAMILUX Ventilation Flaps PR60

## CARITAS, HAGEN

### Project:

Renovation of the roof of the Caritas workshop for people with disabilities: Natural illumination of the premises with around 70 LAMILUX Glass Skylights F100. Flush surface allows rainwater and dirt to run off.

### Systems:

- LAMILUX Glass Skylight F100
- LAMILUX Glass Skylight FE



## WORKSHOPS, STRAUBING

### Project:

Modernisation of a workshop building with over 120 LAMILUX Glass Skylights F100. Increase of natural daylight and reduction of running energy costs.

### Systems:

- LAMILUX Glass Skylights F100 in different sizes
- Interior sun protection



## ST. SEVERIN NURSERY, GARCHING

### Project:

New construction of the nursery with a rippled roof shape. Integration of skylights in the large recreational and dining area.

### Systems:

- 13 LAMILUX Glass Skylights F100 Circular in a fixed design and a structural roof opening size of 150 cm
- Nine LAMILUX Glass Skylights F100 Circular opening for ventilation with a stroke height of 300 mm



LAMILUX

ROOFLIGHT



# LAMILUX

## ROOFLIGHT F100 W

---

The domed rooflight is the ideal skylight on flat roofs of production halls, warehouses, sports and exhibition halls. It not only brings daylight and fresh air into the building, but also ensures the personal and property safety as a smoke and heat exhaust ventilation unit. Thanks to a multi-layered seal system and up to quadruple glazing, the rooflight boasts exceptional heat-insulation values.

With clever geometry instead of more material, the rooflight equips itself for future challenges. The new wave shape of the rooflight shell with its protected design ensures better load transfer and guarantees more stiffness without using more material. This way, the skylight F100 W remains watertight even at higher wind speeds and withstands more wind and snow.

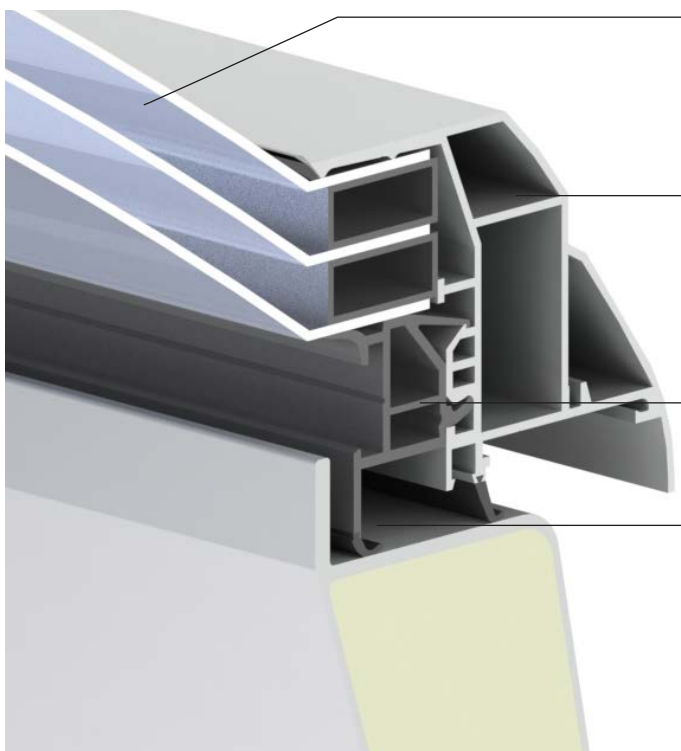

**Stability** – Clever geometry instead of more material due to the wave shape in the glazing.  
Your benefit: Better load transfer and more safety during extreme weather events and a long life span.

**Variety of variants** – individual glazing systems for optimum use of daylight.  
Your benefits: Increase in the well-being of the building users thanks to the natural incidence of light and reduction of electricity costs for electric lighting.

**Flexibility** – plastic glass strip with circumferential functional groove.  
Your benefit: Easy retrofitting with fitting parts possible at any time

**Energy efficiency** – multi-stage sealing system for compact system tightness.  
Your benefit: Heating cost savings and minimised risk of condensation due to excellent thermal insulation of the surrounding frame ( $U_f = 0.76 \text{ W}/(\text{m}^2\text{K})$ )





Product variant LAMILUX Rooflight F100 Circular



Product variant LAMILUX Rooflight F100 W

 **ENERGY EFFICIENCY**

All-round optimum thermal insulation with minimised condensation risk thanks to the overall construction completely free of thermal bridges

Preservation of the thermal energy in the building thanks to the internal, multi-layered seal system

Fully heat-insulated upstand made of GRP, optionally available with heat-insulated base flange

Rooflight with good life cycle assessment and comprehensive environmental product declaration as per DIN EN ISO 14025 and DIN EN 15804 (EPD - modules A1 - D)

 **FUNCTIONALITY IN EXTREME WEATHER CONDITIONS**

Tested watertightness in heavy rain and during storms (Driven Rain Index DRI up to 14.7 m<sup>2</sup>/s)

High stability in heavy rain and during storms

High resistance to wind loads up to UL 1780 as per DIN EN 1873

Hail resistance as per VKF No. 10 test regulations

 **COMFORT & SAFETY**

Easy processing thanks to completely pre-assembled delivery of the skylight

Lockable ventilation as standard with the option of retrofitting ventilation drives at any time

Passive fire protection: Compliance with DIN 18234 for the prevention of fire spread on rooftops without additional measures

Available as certified smoke and heat exhaust ventilation device according to DIN 12101-2

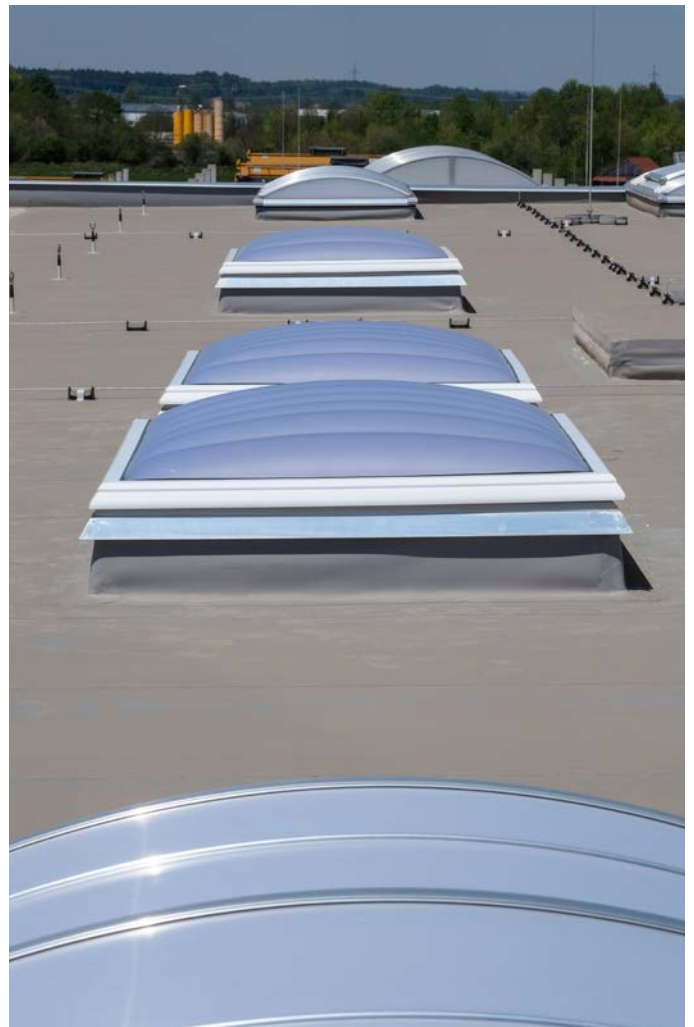

## R-PHARM, ILLERTISSEN

### Project:

Roof renovation of the production facility of the pharmaceutical company R-Pharm Germany in Illertissen. The LAMILUX skylights provide for a pleasant atmosphere and optimum light incidence inside the building. The optimised load transfer and stiffness of the installed elements ensure a high level of safety during extreme weather events.

### Systems:

- 23 LAMILUX Smoke Lift Rooflights F100 W with fall-through grille in 150 x 150 cm
- One LAMILUX Continuous Rooflight B with a length of 8 metres
- With CO2 alarm station

## UNGLEHRT, MEMMINGEN

### Project:

New construction of a production hall for the Unglehrt construction company. The installed LAMILUX Rooflights F100 W and LAMILUX Rooflights B provide optimal daylight illumination in the production hall. Furthermore, the smoke and heat extraction devices serve as preventive fire protection.

### Systems:

- Three LAMILUX Skylights F100 W with fall-through grille in 180 x 240 cm
- Two LAMILUX Smoke Lift Skylights F100 W with fall-through grille in 180 x 240 cm
- Eleven LAMILUX Continuous Rooflights B with fall-through grille and safety stripes, with a length of 5-15 m and a width of 3.5 m
- Seven LAMILUX Smoke and Heat Extraction Units installed in continuous rooflights



## EQUILIBRIUM OFFICE, BUKAREST

### Project:

New construction of an office building in Bucharest, Romania. The approx. 2,000 m<sup>2</sup> office complex has a large covered outdoor area equipped with 11 circular LAMILUX skylights. These ensure an even higher daylight utilisation in the outdoor area of the canteen and are also a visual highlight.

### Systems:

- eleven LAMILUX Rooflights F100 Circular with a diameter of 180 cm and laser grille as fall-through protection in a filigree look

## APARTMENT COMPLEX, GREEN PARK | MOSCOW

### Project:

New construction of a residential complex at Green Park in Moscow. The residential complex has an all-round roofing of the entrance area, which was equipped with 31 circular LAMILUX rooflights. Thanks to daylight illumination they provide a brighter entrance area and visually enhance the building.

### Systems:

- 30 LAMILUX Rooflights F100 Circular, 1-skinned clear
- One LAMILUX Rooflight F100 Circular, 3-skinned clear



**LAMILUX**

**CONTINUOUS ROOFLIGHT**



# LAMILUX

## CONTINUOUS ROOFLIGHT B

---

**Our LAMILUX Continuous Rooflight B is a pioneering skylight in terms of energy and statics. That precisely means that it is an arc-shaped, modular dome light system with an optimised energy balance thanks to its seamless thermal separation. Thanks to the wide range of ventilation and smoke and heat extraction flaps that can be integrated into the continuous rooflight, optimum solutions can be found for almost every type of application for smoke extraction as well as for the aeration and ventilation of the object.**

The LAMILUX Continuous Rooflight B is optimally suited for large-area illumination of halls with daylight as well as for use as large-area heat extraction with the melt-out glazing variants in case of fire. The system is optimised as standard for use as a low-cost solution in industrial halls and warehouses, but can also be manufactured for installation in sports halls and retail outlets, for example, by using glazing with improved thermal insulation properties.

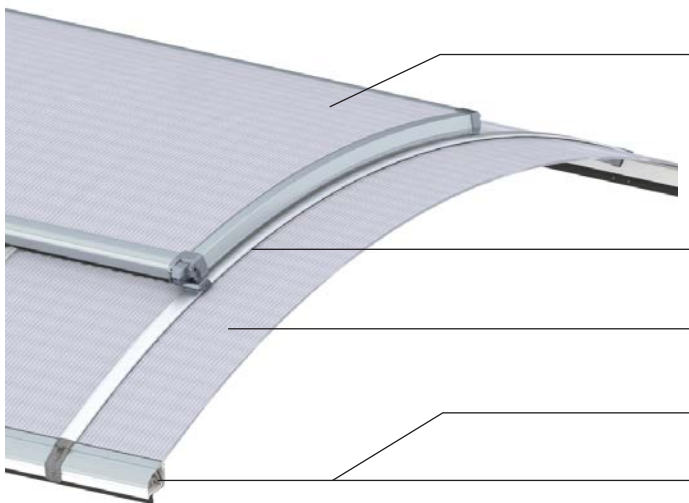

**Arched flap** as ventilation or certified smoke and heat exhaust ventilation **with optimised  $U_f$  values**, excellent thermal values and perfected flap adjustment system

**Tension bar with active expansion absorber**

**Wide range of variants for polycarbonate glazing** for every use

**Isothermal Load Converter**

**Base profile: Effective prevention of fire spreading on the roof as per DIN 18234**

# LAMILUX

## CONTINUOUS ROOFLIGHT S

The LAMILUX Continuous Rooflight S is a modular, ridged roof continuous rooflight system and can be fitted with different composite glazing types according to requirements. Its completely thermally separated profile system ensures optimum thermal protection and minimises the risk of condensation on the construction's surfaces compared with conventional, non-thermally separated structures.

Combined with the frame system, which has been optimised for the construction, ideally matched solutions are possible without additional upstands provided by the client. Optimum smoke removal and ventilation solutions for the property for almost every use as a result of ventilation and smoke and heat exhaust flaps that can be integrated.

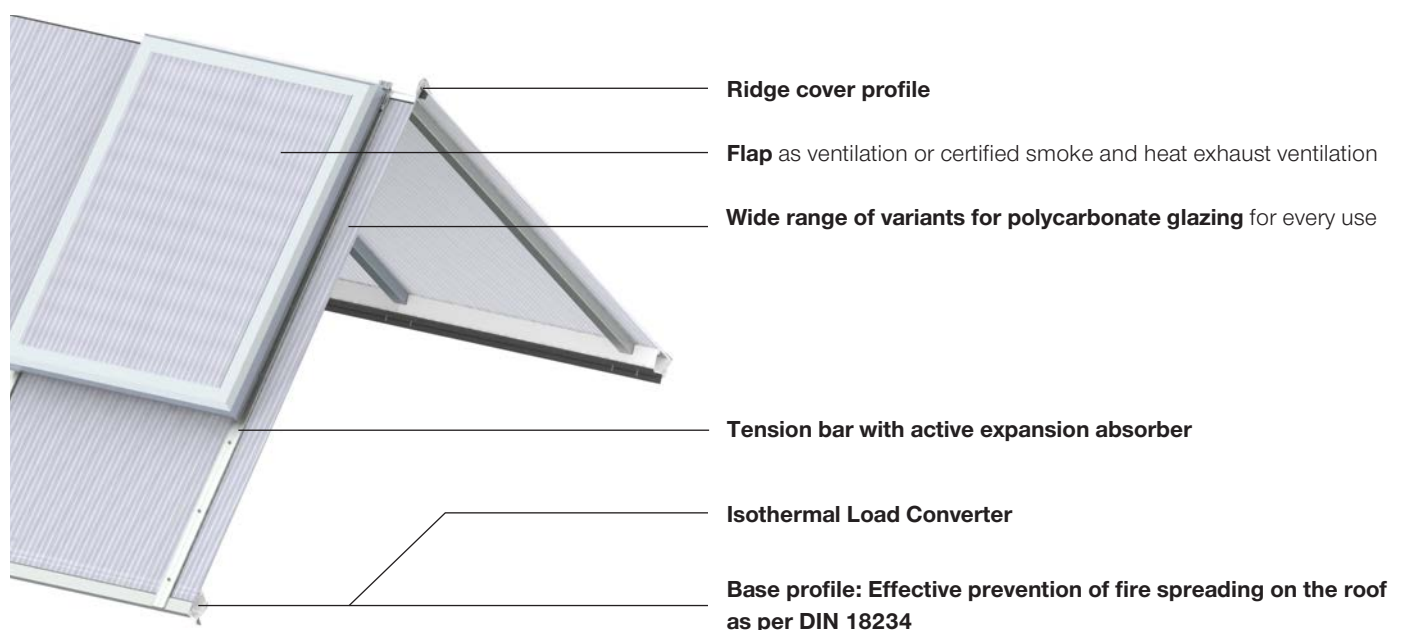



Product variant LAMILUX Continuous Rooflight B Passivhaus

 **ENERGY EFFICIENCY**

Tested and certified heat insulation values (ETA – European Technical Assessment)

Optimisation of isothermal characteristics and rebate base ventilation as well as minimisation of the condensate risk due to thermal separation on all construction components

Optimal insulating effect and air-tightness for the overall structure, suitable for air-tight shells of buildings (blower door)

Customised intake of daylight and solar heat input thanks to object-specific composite glazing with heat transmission coefficients of up to 1.0 W/(m²K)

 **FUNCTIONALITY IN EXTREME WEATHER CONDITIONS**

Durability thanks to the active expansion absorber as optimal protection of the construction in the event of snow, ice, wind and excessive heat

High level of stability and safety under wind and snow loads thanks to the dynamic torque control in the flaps

Resistance to hail tested as per VKF Bern guidelines and tested watertightness in heavy rain and during storms (DRI 3.0 m²/s)

Impervious to driving rain thanks to welded sealing frames for flap systems and certified airtightness for the overall system

 **SAFETY**

Preventive fire protection according to DIN 18234: Prevention of fire spreading on the roof as a result of the Linear Burn-through Protection

Melt-out of the glazing in the event of a fire to ensure heat extraction

Integration of natural smoke and heat exhaust ventilation devices (NSHEV) and smoke and heat exhaust control systems for smoke removal from the building in the event of a fire

Glazing types that are resistant to flying sparks and radiating heat





LAMILUX Continuous Rooflight B



LAMILUX Continuous Rooflight S

## SEST LUVE, GLIWICE | POLAND

### Project:

Continuous rooflights B were installed on the production and storage hall of the Sest Luve company in Gliwice.

### Systems:

- 15 arcade rooflights B with a maximum length of over 60 meters
- 4 LAMILUX smoke and heat extraction units integrated as double vents
- 3 LAMILUX F100

## EVENTS HALL, WURZEN

### Project:

Renovation and conversion of a former production hall into an events hall.

### Systems:

- 21 LAMILUX Continuous Rooflights S 30° with lengths of up to 28 metres
- Eight LAMILUX Smoke Lifts Continuous Rooflight S

# LAMILUX

## TRANSLUCENT FAÇADE AND ROOF

---

The system from LAMILUX enables energy-optimised, break-proof glazing of lateral light surfaces. Non-supporting walls can be used as lighting, ventilation, and smoke and heat extraction surfaces. Ventilation flaps and smoke and heat exhaust ventilation flaps, as well as their various ventilation and activation variants, can be easily integrated into the façade and roof system.

We differentiate between the Translucent Roof, which is installed as shed glazing, and the Translucent Façade, which is installed as a front-mounted facade or in the reveal. With both systems, the daylight can be optimally used through lateral light intake. It enables a clear-cut architectural division of the facade. Its completely thermally separated profile system ensures optimum thermal protection and minimises the risk of condensation on the construction's surfaces.



**Flap** as ventilation or certified smoke and heat exhaust ventilation (also with roda single and double flap ventilator Phoenix and louvre ventilator Smokejet available)

**Range of variants for polycarbonate glazing**

**Capping section**

**Thermally separated aluminium profile**



## ALTER POSTBAHNHOF, LEIPZIG

### Project:

Renovation of Alter Postbahnhof in Leipzig to create commercial and office spaces.

### Systems:

- Ten LAMILUX Translucent Façade and Roof systems as shed roof with a surface inclination of 60°
- 47 single flap PHOENIX ventilators of our subsidiary roda



## COROPLAST, WUPPERTAL

### Project:

Supplying a production hall with maximum daylight.

### Systems:

- LAMILUX Translucent Façade and Roof system as a shed construction with a length of 18 metres in an overall system completely free of thermal bridges
- 15 SMOKEJET louvered ventilators of our subsidiary roda



**LAMILUX**

**LAMILUX WINDOWS FIRE RESISTANCE**



# LAMILUX

## WINDOWS FIRE RESISTANCE

---

**LAMILUX offers a range of fire resistant windows called Fire Resistance, which is classified according to the European standard EN 13501-2.**

**These fire resistant windows are available as fire resistant glass skylight and fire resistant glass roofs. With fire-resistant glazing, the Glass Skylight can withstand 30, 60 or 90 minutes of fire and heat, depending on the requirements of the building. With the new award-winning Glass Skylight Fire Resistance REI90, we have succeeded in extending the previous protection to 90 minutes. The Glass Roof version offers 30 or 60 minutes of adequate protection in case of fire.**

The LAMILUX Glass Skylight Fire Resistance is delivered to the construction site as a completely pre-assembled element on a steel upstand. For larger roof openings, LAMILUX offers the Glass Roof Fire Resistance, which is installed directly on site and guarantees an aesthetically appealing appearance that can hardly be distinguished from conventional LAMILUX glass roofs.



 **OPTIMISED SEALING AND DRAINAGE SYSTEM**

Efficient ventilation of glazing rebates and controlled drainage of water and condensate

Overlapping, multi-layered sealing system, designed without direct joints and a secondary drainage system in the inner sealing layer

Joint-free, continuous drainage level on the mullion/transom

Increase and improvement of the surface temperature on the glass edge and subsequent reduction in risk of condensation

 **PRODUCT VARIETY IN HIGH QUALITY STANDARDS**

Various fire protection windows available in all fire resistance classes

German Design Award 2023 in the category „Excellent Product Design - Building and Elements“ for our new Glass Skylight Fire Resistance REI 90

Visible elements of the supporting structure with RAL coatings

Visible or concealed screw connection of the ceiling strips possible

 **SAFETY**

Fire resistance with the functional integrity of the complete system certified to 30 minutes / 60 minutes / 90 minutes

Resistance to external fire exposure from flying sparks and radiating heat with classification B<sub>ROOF</sub> (t1) as per DIN EN 13501-5

Classification according to EN 13501-2

 **ACTIVE ENERGY MANAGEMENT**

Reduction of heat loss in the frame

Optimised building energy balance through improved thermal insulation

Combination of fire protection properties and energy benefits

# LAMILUX SMOKE AND HEAT EXHAUST VENTILATION SYSTEMS

---

**Natural smoke and heat exhaust ventilation units (NSHEVs) save lives and protect property. This is why all LAMILUX product groups are also available as NSHEV. LAMILUX smoke and heat exhaust ventilation (also SHEV) systems are synonymous with safety in compliance with DIN EN 12101-2, DIN 18232, the German Industrial Building Guidelines and various VdS guidelines.**

These systems use thermal lift to channel smoke, heat and fumes into the open air. As fresh air is drawn in, a smoke-free layer forms near to the ground: As a result, people are able to escape quickly into the open air and the rescue services can extinguish the fire and save lives safely and do so with the necessary visibility.



LAMILUX Smoke Lift Rooflight F100 W





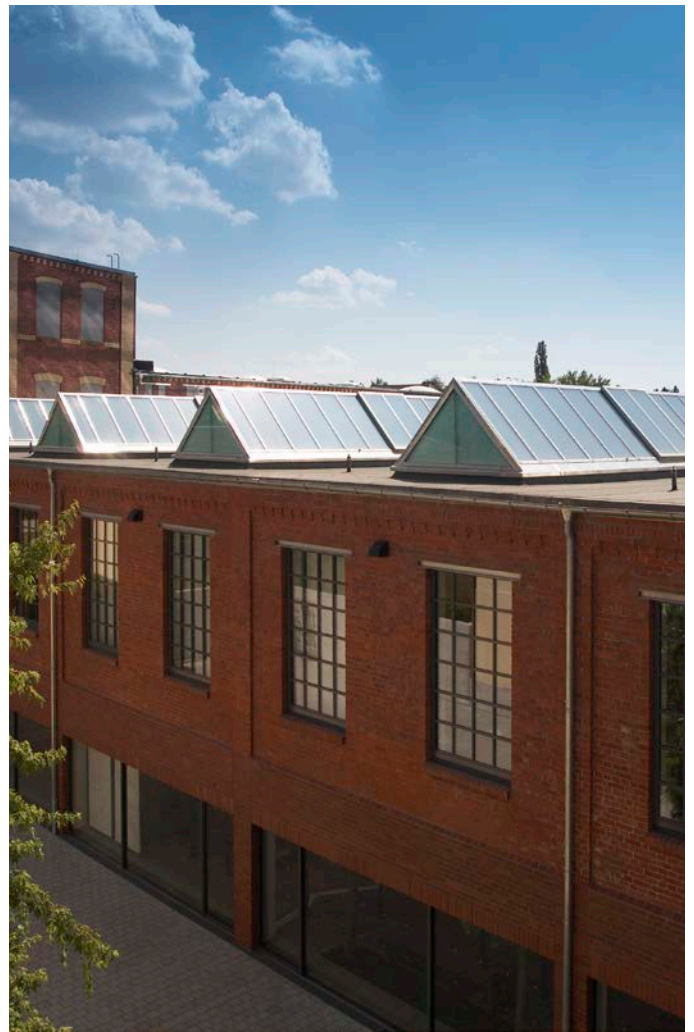

## MAINTENANCE

Smoke and heat exhaust ventilation systems must trigger and respond quickly and correctly in case of fire. In other words, 100 percent reliability and functionality of the SHEV system. For this reason, regular maintenance is a must for SHEV system operators, as they are legally required to take any necessary measures to keep people out of danger in the event of a fire.

### Key maintenance items:

- Examination of the overall system for modifications performed by the operator
- Test activation via CO<sub>2</sub> lines
- Testing of electrical wiring and accumulators
- Inspection of CO<sub>2</sub> cartridge filling levels
- Cleaning of SHEVs to remove dust, oily deposits and corrosion
- Complete activation of the SHEV system
- Transparent documentation of the work carried out

## RENOVATION

Retrofitting of skylights with LAMILUX means: All processes take place transparently and in accordance with a customer and result-oriented methodology – from planning through to installation. We record the many parameters involved in a renovation using a detailed checklist and then implement the clearly regulated steps in practice and on time.

### The overall LAMILUX renovation package:

- Survey by LAMILUX
- Clarification of requirements
- Drafting of a proposal
- Organisation of coordinated measures
- Assembly, including control technology
- Maintenance in accordance with the applicable guidelines
- Short renovation times
- Disassembly and assembly also during on-going production
- High level of planning and cost security



## RENOVATION EXAMPLE DANTE GYMNASIUM, MUNICH

### Before the renovation

Heat energy was shown to escape from the old glass roof. The supporting structure had become unstable and the partly opaque glass panes were only letting a small amount of daylight into the building.

### After the renovation

- Two hipped glass roofs with a surface inclination of 20° with dado wall panelling
- Coating of both constructions in customised RAL colours
- Option of daily ventilation with 24 LAMILUX Ventilation Flaps PR60
- Activation of the systems by means of 24 motor openers as flap drives for ventilation and SHEV function
- Installation of supply cable and ventilation control connection to the existing building control system

# STEEL CONSTRUCTIONS WITH MIROTEC

---

**Large glass roofs can no longer support aluminium alone. This is where steel supporting constructions come into play – and we can offer you these as well: Our subsidiary Mirotec, which has its HQ in Wetztingen (Germany), is a well-known European steel-glass construction specialist. Using state-of-the-art technology which makes it possible to create highly complex constructions via CAD, we are able to make your architectural ideas a reality.**

In this regard, we attribute great importance to aesthetics, modernity and environmental compatibility which we believe are fundamental requirements of modern building constructions. Your biggest benefit from the LAMILUX and Mirotec combination: You reduce the number of interfaces you need by one and you hire two experts who have already implemented many projects together. You benefit from synergy effects which you will notice both in terms of time and cost.



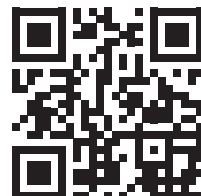

# VENTILATION TECHNOLOGY WITH RODA

---

**roda Licht- und Lufttechnik GmbH has been part of the LAMILUX Group since January 2018. The subsidiary's product portfolio covers four core competences: smoke and heat exhaust ventilation, industrial ventilation, daylight technology and translucent facade technology. roda takes care of all project planning up to on-site acceptance. In addition, roda offers maintenance for SHEV systems of all manufacturers as well as renovations within the scope of the four stated core competences.**

**LAMILUX and roda work together very closely in both development and sales. The benefit for you as a customer: One central contact, no interfaces, larger product portfolio and volume of services.**

The first collaborative product is a thermally separated continuous rooflight with rainproof ventilation: The connection between the LAMILUX Continuous Rooflight B and the MEGAPHOENIX double flap from roda. The element guarantees all-weather ventilation through its weather-resistant side opening flaps. These open automatically as soon as the top-mounted flaps close when it starts to rain.

The MEGAPHOENIX can be mounted directly on the continuous rooflight frame with a continuous rooflight width of up to three metres. From a continuous rooflight width of more than three metres, the MEGAPHOENIX is mounted as a "rider" directly on the glazing bars of the continuous rooflight without interruptions.

A further collaborative solution is the integration of roda's louvered ventilators into the LAMILUX Continuous Rooflight S.

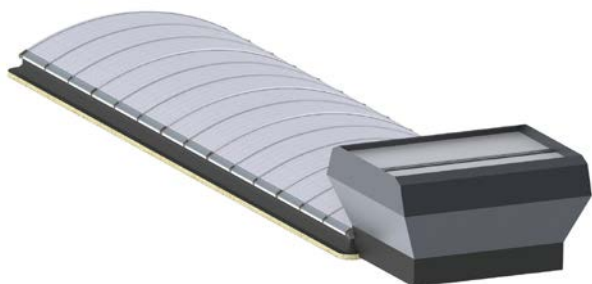

roda MEGAPHOENIX on the frame of the LAMILUX Continuous Rooflight B



roda MEGAPHOENIX on the glazing bar of the LAMILUX Continuous Rooflight B



PHOENIX



MEGAPHOENIX



FIREFIGHTER



SMOKEJET



Scan this to learn more about  
LAMILUX skylights!



ROOFLIGHT F100 W



GLASS SKYLIGHT F100



GLASS SKYLIGHT FE

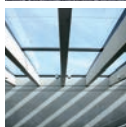

GLASS ARCHITECTURE



FLAT ROOF ACCESS HATCH

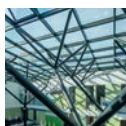

MIROTEC STEEL CONSTRUCTIONS



CONTINUOUS ROOFLIGHT B/S



RENOVATION



TRANSLUCENT FAÇADE AND ROOF



SMOKE AND HEAT EXHAUST  
VENTILATION SYSTEMS



RODA LIGHT AND AIR TECHNOLOGY



MODULAR GLASS SKYLIGHT MS78

The technical data listed in this brochure correspond to the current status at the time of printing and are subject to change. Our technical specifications are based on calculations and supplier specifications, or have been determined by independent testing authorities within the scope of applicable standards.

Thermal transmission coefficients for our plastic glazing were calculated using the finite element method with reference values in accordance with DIN EN 673 for insulated glass. Taking into account practical experience and the specific characteristics of plastic, the temperature difference between the outer surfaces of the material was defined as 15 K. Functional values refer to test specimens and the dimensions used in testing only. We cannot provide any further guarantees of technical values. This particularly applies to changed installation conditions or if dimensions are re-measured on site.



**LAMILUX Heinrich Strunz GmbH**

Zehstraße 2 · PO Box 1540 · 95111 Rehau · Tel.: +49 (0) 92 83 / 5 95-0 · Fax +49 (0) 92 83 / 5 95-29 0

E-Mail: [information@lamilux.de](mailto:information@lamilux.de) · [www.lamilux.com](http://www.lamilux.com)

